

BETONPRODUCTEN VOOR VARKENS







CIERS BETON

BETONPRODUCTEN

CIERS BETON BVBA is gevestigd in Oostrozebeke. We zijn een familiebedrijf dat reeds meer dan 40 jaar betonproducten produceert.

Het bedrijf is met de broers Omer – Robert en Daniel Ciers eind jaren '60 – begin jaren '70 gestart met een paar handvormen.

Met de volgende generatie hebben we sterk geïnvesteerd in automatisering en werken we met een 10-tal gemotiveerde werknemers.

We beschikken over een eigen labo en doen dagelijks aan interne zelfcontrole om zo de kwaliteit van onze producten te garanderen. We zijn CE gecertificeerd.

Een extern betonadviesbureau helpt ons in het ontwikkelen van accurate recepten en voor het behalen van kwaliteitslabels.







VARKENSROOSTERS

TYPE 1	6
TYPE 2	6
TYPE 3	7
TYPE 4	7
TYPE 5	8

BIGGENROOSTERS

8

CONISCHE GATEN

9

VLOERPLATEN

VOLLE VLOERPLATEN	10
BOLLE VLOERPLAAT	11

STEUNBALKEN EN PALEN

STEUNBALKEN	11
PUNTBALKEN	11
PALEN	11



TYPE 1



LENGTE (cm)	BREEDTE (cm)	HOOGTE (cm)
80	50	10
90	50	10
100	50	10
110	50	10
120	50	10
125	50	10
130	50	10
140	50	10
150	50	10
160	50	10
170	50	10
175	50	10
180	50	10
195	50	10
200	50	10
220	50	10
225	50	10
230	50	10
240	50	10
250	50	10

GLEUFOPENING: 1,8 cm en 2 cm



TYPE 2



LENGTE (cm)	BREEDTE (cm)	HOOGTE (cm)
275	100	15
300	100	15
325	100	15
350	100	15

GLEUFOPENING: 1,8 cm





TYPE 3



LENGTE (cm)	BREEDTE (cm)	HOOGTE (cm)
80	50	8
90	50	8
100	50	8
120	50	8
125	50	8
140	50	8
150	50	8
160	50	8
175	50	8

GLEUFOPENING: 1,8 cm



TYPE 4



A

LENGTE (cm)	BREEDTE (cm)
125	13
150	13
175	13
200	13
220	13
250	13
260	13
270	13
280	13
290	13
300	13
325	13
350	13

B

LENGTE (cm)	BREEDTE (cm)
125	10
150	10
175	10
195	10
200	10
220	10
225	10
250	10

GLEUFOPENING: 1,8 cm

GLEUFOPENING: 1,8 cm



VARKENSROOSTERS

TYPE 5



LENGTE (cm)	BREEDTE (cm)	HOOGTE (cm)
200	33	10
220	33	10
225	33	10
250	33	10

GLEUFOPENING: 2 cm

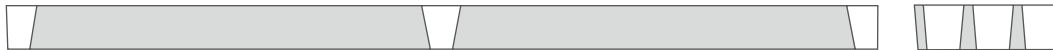

BIGGENROOSTERS

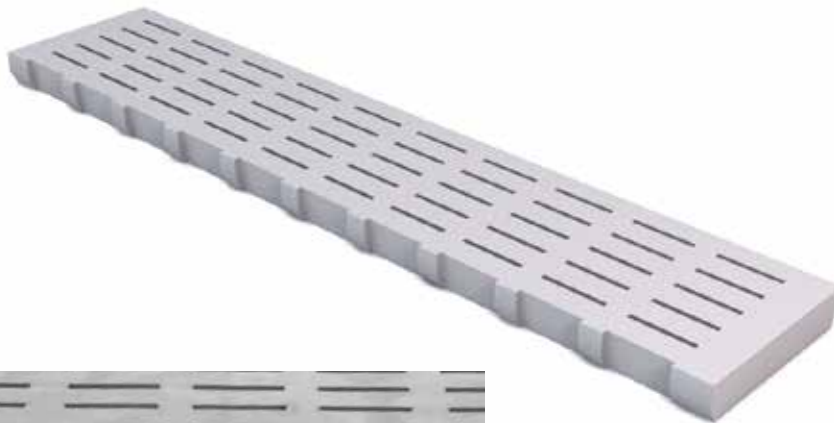

LENGTE (cm)	BREEDTE (cm)	HOOGTE (cm)
80	50	10
90	50	10
100	50	10
125	50	10
150	50	10
175	50	10
200	50	10
220	50	10
250	50	10

GLEUFOPENING: 1,4 cm

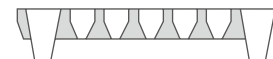
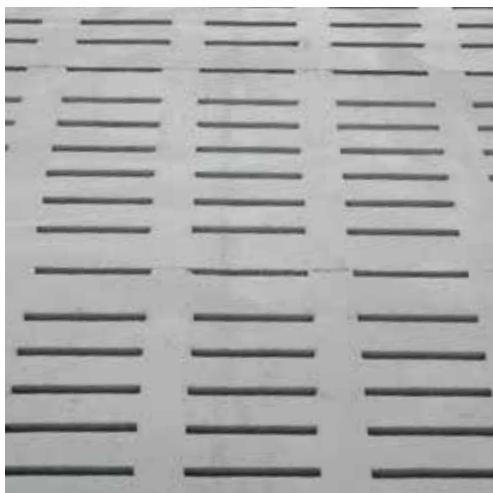



CONISCHE GATEN



LENGTE (cm)	BREEDTE (cm)	DIKTE (cm)
80	50	10
↓ 5 cm		
250	50	10

DOORSNEDE GATEN: 1,7 cm

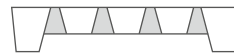



VOLLE VLOERPLATEN



LENGTE (cm)	BREEDTE (cm)	DIKTE (cm)
80	100	10
↓ 5 cm		
275	100	10

LENGTE (cm)	BREEDTE (cm)	DIKTE (cm)
60	50	10
↓ 5 cm		
250	50	10

LENGTE (cm)	BREEDTE (cm)	DIKTE (cm)
60	50	6
↓ 5 cm		
150	50	6

LENGTE (cm)	BREEDTE (cm)	DIKTE (cm)
60	50	7
↓ 5 cm		
220	50	7

LENGTE (cm)	BREEDTE (cm)	DIKTE (cm)
150	100	12
↓ 5 cm		
350	100	12

LENGTE (cm)	BREEDTE (cm)	DIKTE (cm)
200	110	15
↓ 5 cm		
400	110	15

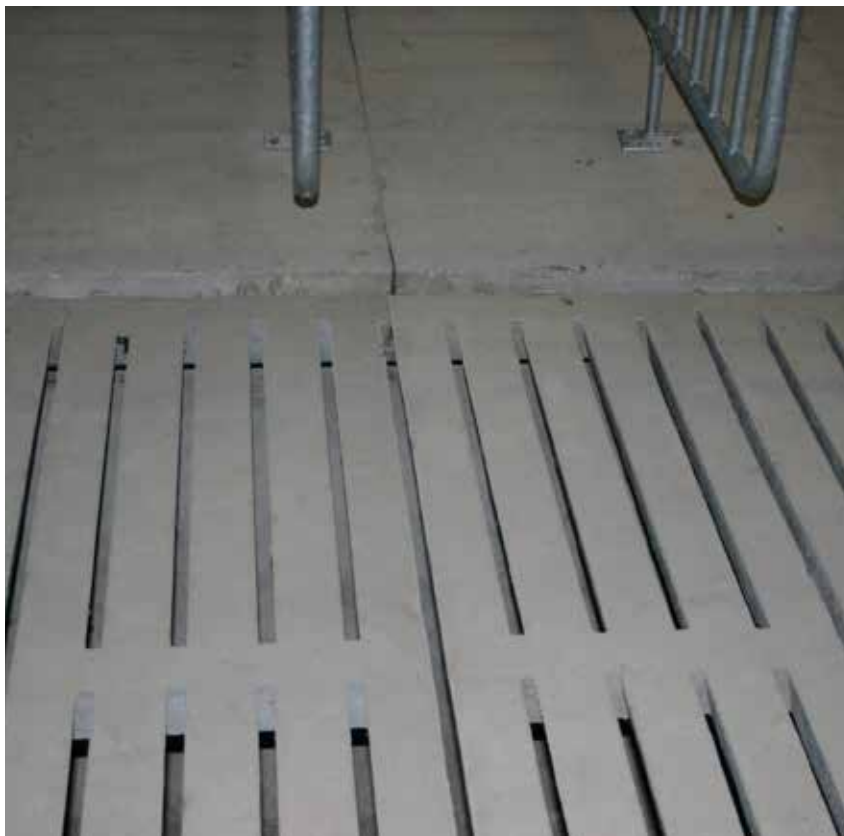



BOLLE VLOERPLAAT

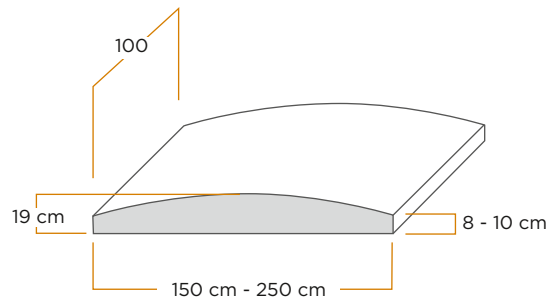

STEUNBALKEN EN PALEN



STEUNBALKEN



VASTE LENGTE OF OP MAAT

LENGTE (cm)	BREEDTE (cm)			HOOGTE (cm)
175	11	16	20	18
200				
210				
220				
225				
250				
275				
300				

PUNTBALKEN



LENGTE (cm)	BREEDTE (cm)		HOOGTE (cm)
	bovenaan	onderaan	
200	5	7	18
225	5	7	
250	5	7	

PALEN



VASTE LENGTE OF OP MAAT

LENGTE (cm)	BREEDTE (cm)			HOOGTE (cm)
60	11	16	20	18
80				
100				
120				
140				
160				
180				
200				



CIERS BETON bvba - Gentstraat 26 - B-8780 Oostrozebeke - T. +32 (0)51 40 08 89 - F. +32(0)51 40 34 48
info@ciersbeton.be - www.ciersbeton.be - RPR Gent, afdeling Kortrijk - BTW BE 0412.921.674