

**CONCRETE
PRODUCTS
FOR PIGS**



cb
CIERS BETON
CONCRETE PRODUCTS







CIERS BETON

CONCRETE PRODUCTS

CIERS BETON BVBA is located in Oostrozebeke, Belgium. We are a family business that has been producing concrete products for over 40 years.

The company started making hand moulds with the brothers Omer, Robert and Daniel Ciers in the late 1960s, early 1970s.

With the following generation we strongly invested in automation and now we work with ten motivated employees.

We have our own lab and carry out internal checks in order to guarantee the quality of our products. We are CE certified.

An external concrete consultancy helps us develop accurate formulas and obtain quality labels.



TABLE OF CONTENTS





PIG FLOORING

TYPE 1	6
TYPE 2	6
TYPE 3	7
TYPE 4	7
TYPE 5	8

PIGLET FLOORING 8

CONICAL HOLES 9

SLATS

FULL SLATS	10
CONVEX SLAT	11

SUPPORT BEAMS AND POLES 11

SUPPORT BEAMS	11
CORNER BEAMS	11
POLES	11



TYPE 1



LENGTH (cm)	WIDTH (cm)	HEIGHT (cm)
80	50	10
90	50	10
100	50	10
110	50	10
120	50	10
125	50	10
130	50	10
140	50	10
150	50	10
160	50	10
170	50	10
175	50	10
180	50	10
195	50	10
200	50	10
220	50	10
225	50	10
230	50	10
240	50	10
250	50	10

SLOTTED APPLICATOR:
1,8 cm and 2 cm

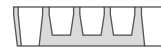

TYPE 2



LENGTH (cm)	WIDTH (cm)	HEIGHT (cm)
275	100	15
300	100	15
325	100	15
350	100	15

SLOTTED APPLICATOR: 1,8 cm





TYPE 3



LENGTH (cm)	WIDTH (cm)	HEIGHT (cm)
80	50	8
90	50	8
100	50	8
120	50	8
125	50	8
140	50	8
150	50	8
160	50	8
175	50	8

SLOTTED APPLICATOR: 1,8 cm



TYPE 4



A

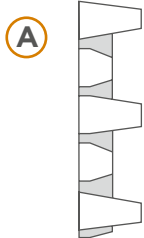

LENGTH (cm)	WIDTH (cm)
125	13
150	13
175	13
200	13
220	13
250	13
260	13
270	13
280	13
290	13
300	13
325	13
350	13

SLOTTED APPLICATOR: 1,8 cm

B

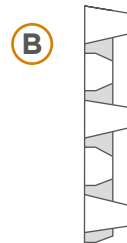

LENGTH (cm)	WIDTH (cm)
125	10
150	10
175	10
195	10
200	10
220	10
225	10
250	10

SLOTTED APPLICATOR: 1,8 cm



PIG FLOORING

TYPE 5



LENGTH (cm)	WIDTH (cm)	HEIGHT (cm)
200	33	10
220	33	10
225	33	10
250	33	10

SLOTTED APPLICATOR: 2 cm



PIGLET FLOORING

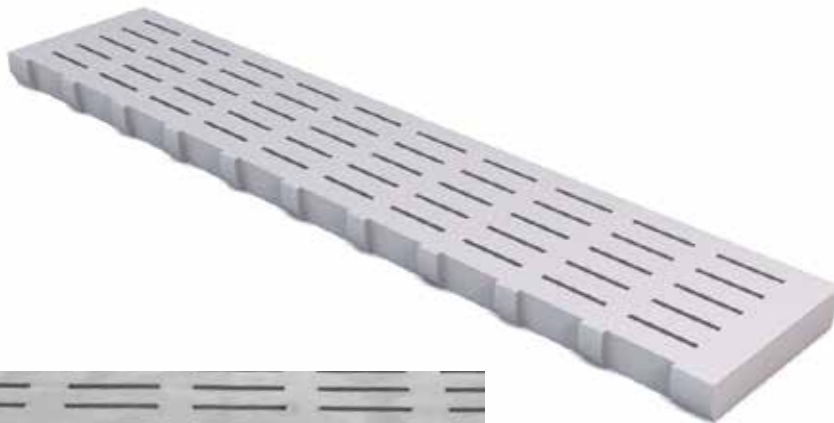

LENGTH (cm)	WIDTH (cm)	HEIGHT (cm)
80	50	10
90	50	10
100	50	10
125	50	10
150	50	10
175	50	10
200	50	10
220	50	10
250	50	10

SLOTTED APPLICATOR: 1,4 cm

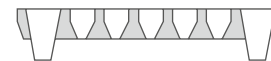
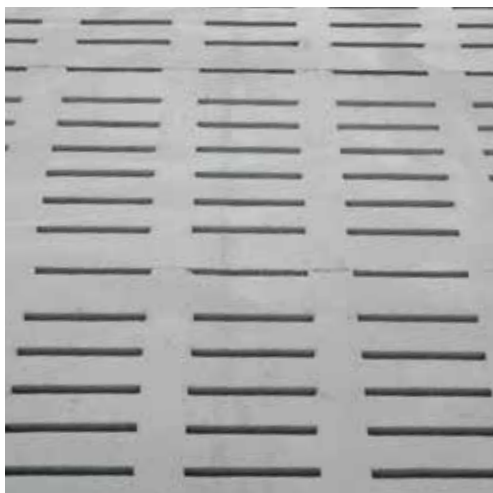



CONICAL HOLES



LENGTH (cm)	WIDTH (cm)	THICKNESS (cm)
80	50	10
↓ 5 cm		
250	50	10

INTERSECTION HOLES: 1,7 cm

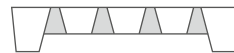



SLATS

FULL SLATS



LENGTH (cm)	WIDTH (cm)	THICKNESS (cm)
80	100	10
↓ 5 cm		
275	100	10

LENGTH (cm)	WIDTH (cm)	THICKNESS (cm)
60	50	10
↓ 5 cm		
250	50	10

LENGTH (cm)	WIDTH (cm)	THICKNESS (cm)
60	50	6
↓ 5 cm		
150	50	6

LENGTH (cm)	WIDTH (cm)	THICKNESS (cm)
60	50	7
↓ 5 cm		
220	50	7

LENGTH (cm)	WIDTH (cm)	THICKNESS (cm)
150	100	12
↓ 5 cm		
350	100	12

LENGTH (cm)	WIDTH (cm)	THICKNESS (cm)
200	110	15
↓ 5 cm		
400	110	15





CONVEX SLATS

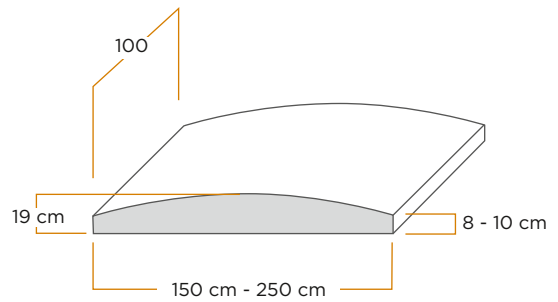

SUPPORT BEAMS AND POLES



SUPPORT BEAMS



FIXED LENGTH OR CUSTOMISED

LENGTH (cm)	WIDTH (cm)			HEIGHT (cm)
175	11	16	20	18
200				
210				
220				
225				
250				
275				
300				

CORNER POLES



LENGTH (cm)	WIDTH (cm)		HEIGHT (cm)
	top	bottom	
200	5	7	18
225	5	7	
250	5	7	

POLES



FIXED LENGTH OR CUSTOMISED

LENGTH (cm)	WIDTH (cm)			HEIGHT (cm)
60	11	16	20	18
80				
100				
120				
140				
160				
180				
200				



CIERS BETON bvba - Gentstraat 26 - B-8780 Oostrozebeke - T. +32 (0)51 40 08 89 - F. +32 (0)51 40 34 48
info@ciersbeton.be - www.ciersbeton.be - RPR Gent, afdeling Kortrijk - VAT BE 0412.921.674